



105 Bonnie Drive
Butler, PA 16002
724-283-4681
724-283-5939 (fax)
www.bwieagle.com

PRODUCT INFORMATION BULLETIN

OVERSPEED MONITOR Fail Safe Overspeed Switch MODEL 22-4100-265-DC Rev.2

DESCRIPTION

The EAGLE OVERSPEED MONITOR is a highly accurate, fail-safe overspeed detector specifically designed to monitor the speed of elevators, overhead cranes and emergency escape hoists. Incorporating advanced electronic technology and innovative circuitry design, the EAGLE OVERSPEED MONITOR sets the standard for dependable, trouble-free performance.

INSTALLATION

DISCONNECT DC power before proceeding with installation.

1. Mount the socket in the existing control panel or suitable protective enclosure.
2. Install EAGLE PROX SENSOR at drum or drum shaft. See sensor installation section.
3. Make the following connections on the socket:

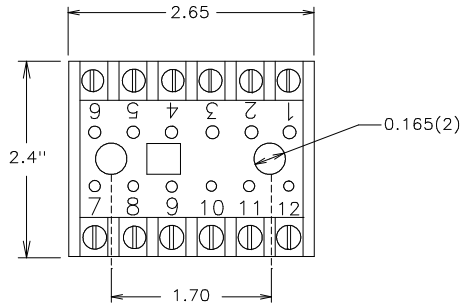

TERMINAL	CONNECTION
1	Sensor Input - Common (-)
2	Sensor Input - Positive (+)
3 - 4	Run/Reset Input From Control Circuit
5	(+) 9-36VDC
6	(-) 9-36VDC
*7	Relay - N/C (1)
*8	Relay - Common
*9	Relay - N/O (1)
*10	Relay - N/C (2)
*11	Relay - Common (2)
*12	Relay - N/O (2)

* Note - When DC power is applied to the unit, the relay will energize. If an overspeed condition or sensor fault condition is detected, the relay will de-energize.



CONTROLS AND INDICATORS

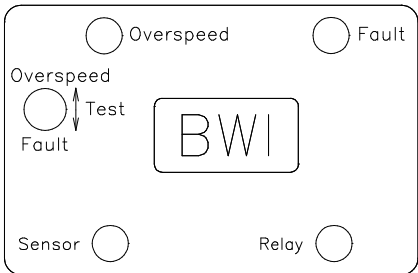

OVERSPEED LED - Green LED that when illuminated, indicates that an overspeed condition was detected by the unit. This is a latching LED that will automatically reset when input terminals 3 and 4 change state.

FAULT LED - Red LED that when illuminated, indicates that a sensor fault condition was detected. Examples: Shorted/open sensor cable or sensor not aligned with targets etc... This is a latching LED that will automatically reset when input terminals 3 and 4 are closed and then re-opened.

SENSOR LED - Pulses at the rate of speed being received by the sensor.

RELAY LED - Illuminated under normal running conditions. LED will go out and relay contacts will open when an "overspeed" or "fault" condition is detected.

TEST SWITCH - An integral 2 position switch for testing the control unit. In the "up" (overspeed) position the sensor input signal is internally increased to the preset RPM Trip Point. This provides a "true" simulation of overspeed to ensure the control unit will respond to an actual overspeed condition without the operator having to re-calibrate the unit. In the "down" (fault) position, the sensor input is internally shorted to simulate a loss of sensor signal that will also de-energize the control relay.

OVERSPEED MONITOR

Fail Safe Overspeed Switch

MODEL 22-4100-265-DC Rev. 2

SET-UP and OPERATION

This unit can be set-up in two different configurations:

Overspeed AND Sensor Fault Monitoring

SET-UP - Install two wires from the run relay in your control circuit to terminals 3 and 4 on the socket of the overspeed monitor. These contacts must be normally closed, and must open when the equipment begins to run.

OVERSPEED OPERATION - When an overspeed condition is detected, the control relay in the overspeed monitor will open to shut down the equipment and the green Overspeed LED will illuminate. This relay will not reset until a contact closure is detected on terminals 3 & 4 and the green Overspeed LED will automatically extinguish.

SENSOR FAULT OPERATION - When a sensor fault is detected, the control relay in the overspeed monitor will open to shut down the equipment and the red Fault LED will illuminate. This relay will not reset until a contact closure is detected on terminals 3 & 4. Fault monitoring will restart when the run relay's contacts are opened again on terminals 3 & 4 and the Fault LED will automatically extinguish.

Overspeed Monitoring ONLY (No Sensor Fault Monitoring)

SET-UP - Install a normally closed dry contact switch to terminals 3 and 4 on the socket of the overspeed monitor.

OVERSPEED OPERATION - When an overspeed condition is detected, the control relay in the overspeed monitor will open to shut down the equipment and the green Overspeed LED will illuminate. This relay will not reset until the normally closed switch on terminals 3 and 4 has been momentarily opened then re-closed. This will re-energize the control relay and the green Overspeed LED will automatically extinguish.

DIMENSIONS

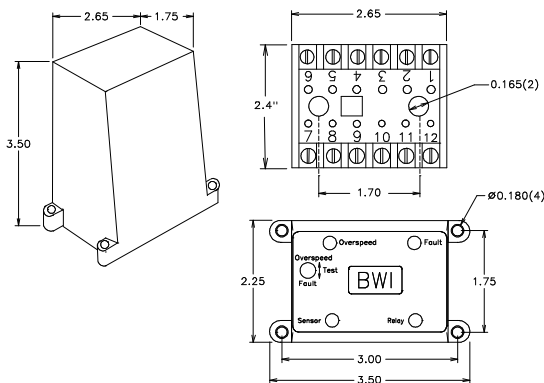

Allow for 5.25" total height with module in socket

SPECIFICATIONS

DC Input	9-36 VDC
Fuse Protected	2 amp
Overspeed Trip Point	265 RPM
RPM Accuracy	+/- 0.4%
Repeatability	+/- 0.1%
Fault Delay	Approx 4 Seconds
Relay Contacts	DPDT 5 amp @ 30 VDC or 240VAC
Enclosure	ABS Plastic

REPLACEMENT AND OPTIONAL PARTS

DESCRIPTION	PART NUMBER
Control Module	22-4102--265-DC
Mounting Socket	22-8003
Threaded PVC Proximity Sensor	10-7139
I.S. Threaded PVC Proximity Sensor	10-7039 - IA444-1
I.S. Zener Barrier	10-7072 - IA446-0

DOCUMENT DATE: 5-Nov-08



105 Bonnie Drive
Butler, PA 16002
(724) 283-4681
Fax (724) 283-5939
www.bwieagle.com