



105 Bonnie Drive
Butler, PA 16002
724-283-4681
724-283-5939 (fax)
www.bwieagle.com

PRODUCT INFORMATION BULLETIN

OVERSPEED MONITOR Fail Safe Overspeed Switch MODEL 22-4100-500 Rev.2

DESCRIPTION

The EAGLE OVERSPEED MONITOR is a highly accurate, fail-safe overspeed detector specifically designed to monitor the speed of elevators, overhead cranes and emergency escape hoists. Incorporating advanced electronic technology and innovative circuitry design, the EAGLE OVERSPEED MONITOR sets the standard for dependable, trouble-free performance.

INSTALLATION

DISCONNECT AC power before proceeding with installation.

1. Mount the socket in the existing control panel or suitable protective enclosure.
2. Install EAGLE PROX SENSOR at drum or drum shaft. See sensor installation section.
3. Make the following connections on the socket:

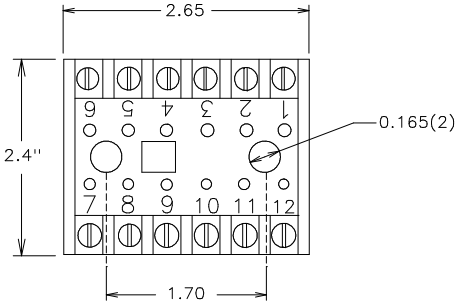

TERMINAL	CONNECTION
1	Sensor Input - Common (-)
2	Sensor Input - Positive (+)
3 - 4	Run/Reset Input From Control Circuit
5 - 6	120 VAC Input
*7	Relay - N/C (1)
*8	Relay - Common
*9	Relay - N/O (1)
*10	Relay - N/C (2)
*11	Relay - Common (2)
*12	Relay - N/O (2)

* Note - When AC power is applied to the unit, the relay will energize. If an overspeed condition or sensor fault condition is detected, the relay will de-energize.



CONTROLS AND INDICATORS

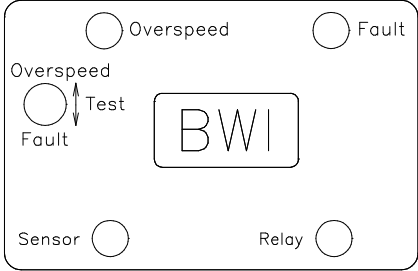

OVERSPEED LED - Green LED that when illuminated, indicates that an overspeed condition was detected by the unit. This is a latching LED that will automatically reset when input terminals 3 and 4 change state.

FAULT LED - Red LED that when illuminated, indicates that a sensor fault condition was detected. Examples: Shorted/open sensor cable or sensor not aligned with targets etc... This is a latching LED that will automatically reset when input terminals 3 and 4 are closed and then re-opened.

SENSOR LED - Pulses at the rate of speed being received by the sensor.

RELAY LED - Illuminated under normal running conditions. LED will go out and relay contacts will open when an "overspeed" or "fault" condition is detected.

TEST SWITCH - An integral 2 position switch for testing the control unit. In the "up" (overspeed) position the sensor input signal is internally increased to the preset RPM Trip Point. This provides a "true" simulation of overspeed to ensure the control unit will respond to an actual overspeed condition without the operator having to re-calibrate the unit. In the "down" (fault) position, the sensor input is internally shorted to simulate a loss of sensor signal that will also de-energize the control relay.

