



238 Pillow Street
Butler, PA 16001
724-283-4681
724-283-5939 (fax)
www.bwieagle.com

PRODUCT INFORMATION BULLETIN

MOTOR OVERSPEED DECODER

Overspeed Control Module

MODEL 22-4300-9800

DESCRIPTION

The EAGLE MOTOR OVERSPEED DISPLAY SYSTEM is a highly accurate, fail-safe overspeed detector specifically designed to monitor and display the speed of DC powered mobile equipment. Incorporating advanced electronic technology and innovative circuitry design, the EAGLE MOTOR OVERSPEED DISPLAY SYSTEM sets the standard for dependable, trouble-free performance.

INSTALLATION

DISCONNECT DC power before proceeding with installation.

1. Mount the MOTOR OVERSPEED DECODER socket in the existing control panel or suitable protective enclosure.
2. Mount the REMOTE HEADLAMP DISPLAY in the operator cabinet.
3. Install EAGLE I.S. PROX SENSOR and ZENER BARRIER at drum or drum shaft. See sensor installation sheet.
4. Make the following connections on the socket:

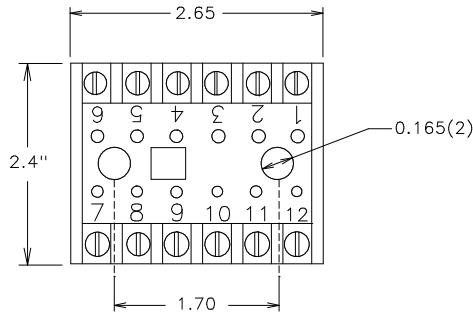

TERMINAL	CONNECTION
1	Sensor Input - Common (-)
2	Sensor Input - Positive (+)
3	(-) 12 VDC Output to Display (Negative)
4	(+) 12 VDC Output to Display (Positive)
5	(+) 12 VDC Input
6	(-) 12 VDC Input
7	B0 Output to Display
8	B1 Output to Display
9	B2 Output to Display
*10	Relay - N/C
*11	Relay - Common
*12	Relay - N/O

* Note - When DC power is applied to the unit, the relay will energize. If an overspeed condition occurs or DC power is lost, the relay will de-energize.

CONTROLS AND INDICATORS

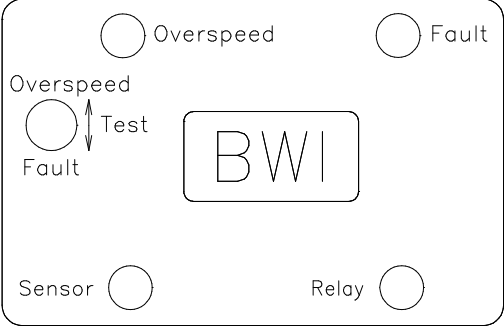

OVERSPEED LED - When illuminated, indicates that an overspeed condition was detected by the unit. This is a latching LED that will automatically reset when the Reset input signal falls below 90%.

FAULT LED - This feature not activated on this model.

SENSOR LED - Pulses at the rate of speed being received by the sensor.

RELAY LED - Illuminated under normal running conditions. LED will go out and relay contacts will open when an overspeed condition is detected.

TEST SWITCH - An integral 2 position switch for testing the control unit. In the "up" (overspeed) position the sensor input signal is internally increased to the preset RPM Trip Point. This provides a "true" simulation of overspeed to ensure the control unit will respond to an actual overspeed condition without the operator having to re-calibrate the unit. The "down" (fault) position is not used on this model.

MOTOR OVERSPEED DECODER

Overspeed Control Module

MODEL 22-4300-9800

DIMENSIONS

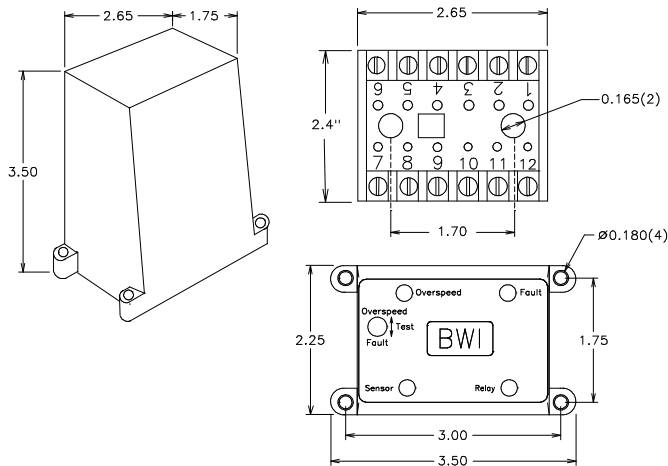

Allow for 5.25" total height with module in socket

SPECIFICATIONS

DC Input	9 VDC - 18 VDC
Fuse Protected	2 amp
Overspeed Trip Point	9800 RPM
RPM Accuracy	+/- 0.4%
Repeatability	+/- 0.1%
Relay Contacts	SPDT 2 amp @ 12 VDC
Enclosure	ABS Plastic

REPLACEMENT AND OPTIONAL PARTS

DESCRIPTION	PART NUMBER
Control Module	22-4302-9800
Mounting Socket	22-8003
Display Unit with XP Housing	22-7300
I.S. Threaded PVC Proximity Sensor	10-7039 - IA444-1
I.S. Zener Barrier	10-7072 - IA446-0

DOCUMENT DATE: 2-May-02



238 Pillow Street
Butler, PA 16001
(724) 283-4681
Fax (724) 283-5939
www.bwieagle.com