



105 Bonnie Drive
Butler, PA 16002
724-283-4681
724-283-5939 (fax)
www.bwieagle.com

PRODUCT INFORMATION BULLETIN

AIR-EAGLE® XLT 900 MHz RF Transmitter MODEL 44-1200-120VAC

DESCRIPTION

The AIR-EAGLE XLT MODEL 44-1200-120VAC, is an R.F. transmitter designed to send a single stop command to any Air-Eagle XLT Receiver. The TX and RX combine to create a long range radio frequency system that operates hazardous or hard-to-reach electrical apparatus from safe, convenient locations of up to 2500 feet away (Up to 2 mile range with optional antennas). This unit is user-programmable for up seven network frequencies to allow multiple transmitters and receivers to operate simultaneously in the same area without interference.

INSTALLATION

1. Mount the AIR-EAGLE XLT TRANSMITTER in a convenient location where the operator will have easy access to the stop button.
2. Install Ch. 2-4 wiring to contact input terminal strip if desired.
3. Install antenna onto connector on the right side of the enclosure.
4. Plug supplied AC wall adapter into AC outlet.

TERMINAL STRIP WIRING

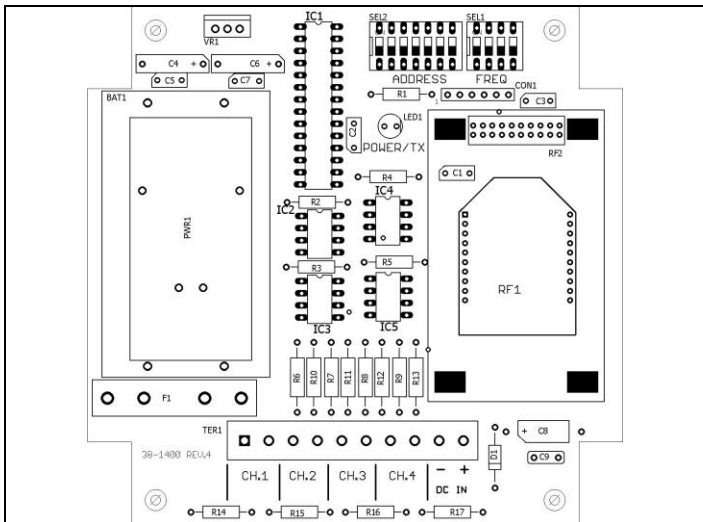

Wire as shown based on number of contact inputs

1	2	3	4	5	6	7	8	9	10
E-Stop Button Pre-Wired to Input 1	C Input 2	Input 2	C Input 3	Input 3	C Input 4	Input 4	(-) 12VDC input from included AC wall adapter	(+) 12VDC input from included AC wall adapter	



Dimensions (with mounting plate) 6.3" L x 4.8" W x 4.3" H

CONTROLS & INDICATORS

PWR/TX LED	Illuminates green continuously while power is applied. Changes to red when transmitting data.
STOP Pushbutton	Transmits CH1 RF "STOP" code to receiver
Inputs 2, 3 and 4	Independently transmit CH2, CH3 and CH4 codes to receiver

FREQUENCY SET-UP

The unit is shipped from the factory with all SEL2 switches in the open positions. By default, it is operating on Frequency #1. If you wish to change the frequency, follow the instructions on the table below.

- 1) Remove power from unit and take cover off.
- 2) Select desired frequency using table below.
- 3) Reattach cover and apply power. Programming is now complete.

FREQUENCY SET-UP				
	Network Frequency	SW1	SW2	SW3
SEL1 (SW1-3)	1 (default)	OPEN	OPEN	OPEN
	2	CLOSED	OPEN	OPEN
	3	OPEN	CLOSED	OPEN
	4	CLOSED	CLOSED	OPEN
	5	OPEN	OPEN	CLOSED
	6	CLOSED	OPEN	CLOSED
	7	OPEN	CLOSED	CLOSED

Note – SW4 not used

AIR-EAGLE® XLT

900 MHz RF Transmitter

MODEL 44-1200-120VAC

APPROVALS

United States (FCC)	MCQ-XB900HP
Canada (IC)	1846A-XB900HP

SPECIFICATIONS

AC Input	100-240 VAC, 16 W, 50/60 Hz from supplied wall adapter
Transmit Data Channels	Four Dry Contact Input
RF Output Power	250 mW
Transmit Range	Approximately 2500 Feet w/standard antenna
Transmit Frequency	900MHz Spread Spectrum
Frequency Channels	7 Independent Network Frequencies
Enclosure	Polycarbonate, IP66 (NEMA 4)
Antenna Connection	TNC Female
Operating Temperature	-40° F to +185° F

REPLACEMENT PARTS & ACCESSORIES

PC Board (Main)	44-1202-120VAC
Standard Antenna (Included):	
900MHz TNC Portable Antenna (For distances up to 2500 feet*)	49-1101
Optional Antennas and Accessories – Used to increase range in both non line of sight and line of sight applications. - Contact BWI Eagle for recommendations	
900MHz Thru-Hole Mount Mobile Antenna	49-2101
900MHz Magnetic Mount Mobile Antenna	49-2102
900MHz Omni Directional Antenna	49-3101
900MHz 13dB Yagi Antenna	49-3102
Flex Coax Cable w/Connectors – Connects external antenna(s) to base unit(s).	49-4000-XX (XX = # of Feet)
* = Line of Sight	

LIMITED WARRANTY STATEMENT

BWI Eagle Inc. warrants the Air-Eagle Remote Control System, if properly used and installed, will be free from defects in material and workmanship for a period of 1 year after date of purchase. Said warranty to include the repair or replacement of defective equipment. This warranty does not cover damage due to external causes, including accident, problems with electrical power, usage not in accordance with product instructions, misuse, neglect, alteration, repair, improper installation, or improper testing. This limited warranty, and any implied warranties that may exist under state law, apply only to the original purchaser of the equipment, and last only for as long as such purchaser continues to own the equipment. This warranty replaces all other warranties, express or implied including, but not limited to, the implied warranties of merchantability and fitness for a particular purpose. BWI Eagle makes no express warranties beyond those stated here. BWI disclaims without limitation, implied warranties of merchantability and fitness for a particular purpose. Some jurisdictions do not allow the exclusion of implied warranties so this limitation may not apply to you. To obtain warranty service, contact BWI Eagle for a return material authorization. When returning equipment to BWI Eagle, the customer assumes the risk of damage or loss during shipping and is responsible for the shipping costs incurred.

DOCUMENT DATE: 03/01/2019 / PRODUCT REV. 4



105 Bonnie Drive
Butler, PA 16002
(724) 283-4681
Fax (724) 283-5939
www.bwieagle.com



105 Bonnie Drive
Butler, PA 16002
724-283-4681
724-283-5939 (fax)
www.bwieagle.com

DRY CONTACT INPUT WIRING 4-Input Transmitter

Standard wiring of a dry contact input transmitter

Shorting together the contacts of the respective channel will cause it to transmit. This can be done with any type of manual or automatic switch.

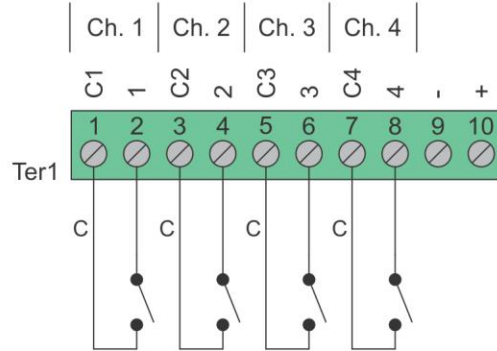

Standard Wiring for Common Ground Applications

Because each channel shares a common (C) terminal, inputs can be wired as shown to allow for fewer conductors to be run to the transmitter.

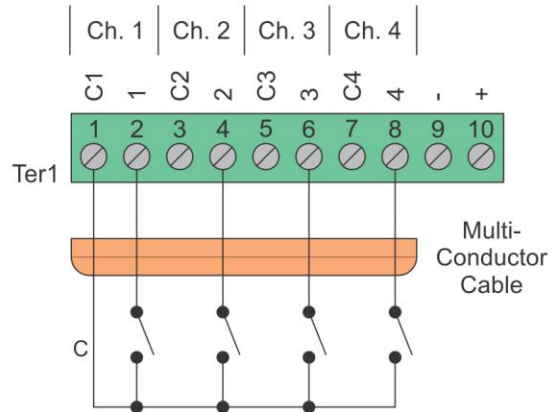

SPDT Switches

The common (C) terminal of the switch only needs to be connected to one of the channels ground terminal. In this configuration two channels would be transmitting all the time. A switch with a center "off" position would allow transmitting to stop. In this example channels 2 and 4 are transmitting.

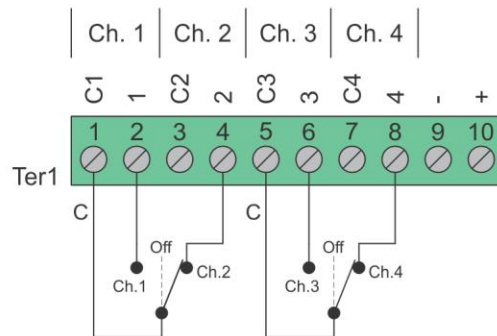

Wiring configurations shown here are examples. The wiring for your application may differ.
Call BWI Eagle for assistance or consult an electrician.